

Cadillac® EP Series Heavy-Duty, Explosion Proof Connectors for Hazardous Environments



Distributed by:
Eastern Connector Specialty
Toll Free: 1-877-788-0888
Direct: 1-860-355-8100
sales@easternconnector.com



**Clements
National
Company**



Catalog Contents

EP Series Product Features	1
Plug & Receptacle Part Number Code Logic	2
Connector Component Overview	3
Connector Major Components	4
Straight Plug Assemblies	5
In-Line Receptacle Assemblies	6
Panel Mount & Fixed In-Line Receptacle Assemblies	7
Insert Configuration Introduction	8
Insert Configuration Listing	9
Insert Configuration Layouts	10-13
Cable Grip Components - Basket Weave Grips, Sealing Grommets & Washers	14
Ex d Gland Size and Cable Types	15
Contact Crimp Termination Tools	16
General Assembly Instructions and Precautions	17-21
Sales Offices & Distributor Listing	Back Cover

Clements National Company

6650 S. Narragansett Avenue, Chicago, Illinois 60638
Toll Free: 800-966-0016
Phone: 708-594-5890 • Fax: 708-594-2481
www.cadillacproducts.com • www.clementsnational.com



EP (Explosion Proof) Series Products

The EP Series is ATEX certified for use in hazardous environments. Classified facilities such as petrochemical refineries, land and offshore drilling systems are just a few of the applications for this product series.

Category	Category Description	Zone Gas (G)	Zone Dust (D)
2	Flammable Material Present Intermittantly	1	21
3	Flammable Material Present Abnormally	2	22

Product Features:

- Hazardous area, environmental connector rated IP68
- For use in a zone 1-IIC environment
- Ex d IIA, IIB, IIC-T6, flame and dust proof
- Ratings, Ex d, and Ex de for panel mounting
- Globally recognized for use in explosive atmospheres
- Designed for the roughest industrial applications
- Large coupling sleeve, secured with captive set screws
- Strong machined aluminum construction
- Secure single lead threaded coupling system
- Durable, Scratch resistant black Hardcoat Plating
- Vast family of reversible inserts, for power, signal and mixed applications
- From 1 to 68 contact positions
- Contact sizes for 18, 16, 12, 10, 8, 4, 1/0, 4/0 AWG
- Shell sizes 6, 8, 10. Consult factory for other shell sizes
- Extensive array of hardware & strain relief options
- Custom cable assembly manufacture to support customer application specific designs

Market applications:

- Offshore Oil Rigs
- Offshore Production Platforms
- Fuel Storage Areas
- Airport Fueling Pits
- Paint Spray Booths
- Paint Storage Areas
- Pharmaceutical Manufacturing Equipment





Part Number Code Logic

EP13-2-XXC06-310PN01A

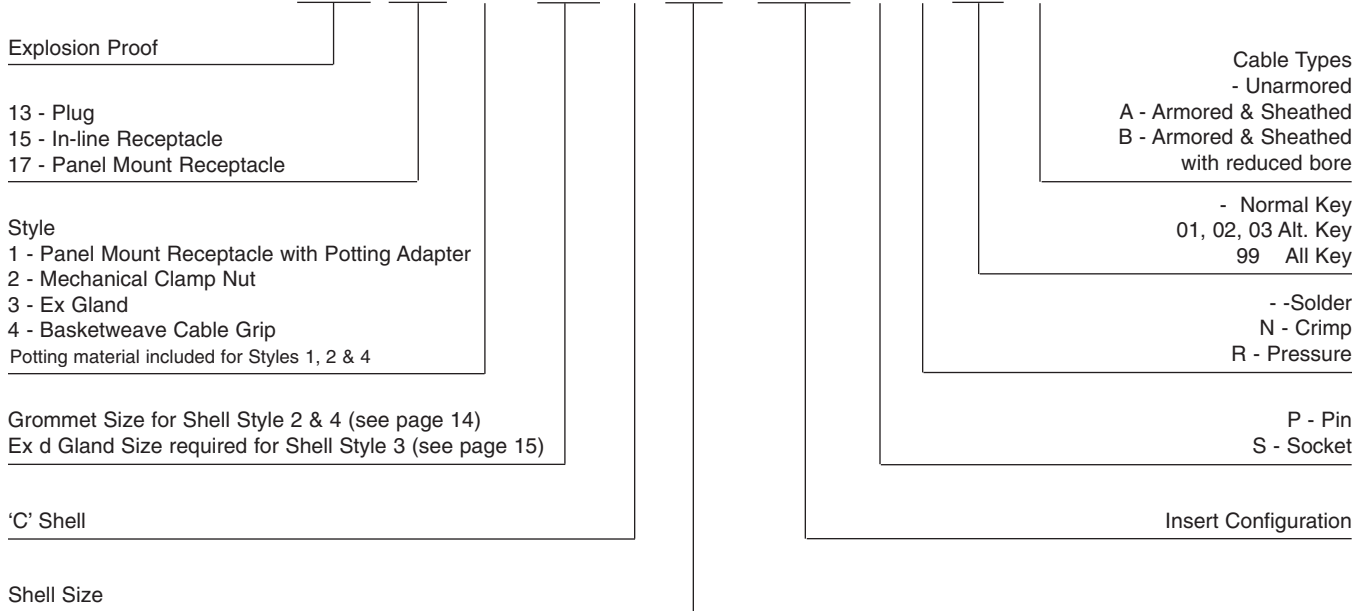

Certification: Intertek ITS08ATEX15968X • Ex d, Ex de, T6 • Protection Class IP68

Part Number Examples

EP15-4-1610-310PN

Shell size 10 In-line Receptacle with Basketweave Cable Grip, Cable O.D. 0.95", Insert #310 with Normal Key, Crimp Pin Contacts, 37 X 12 Awg

EP13-4-1610-310SN

Shell size 10 Plug with Basketweave Cable Grip, Cable O.D. 0.95", Insert #310 with Normal Key. Crimp Socket Contacts, 37 X 12 Awg

EP13-3-A06-327SN

Shell size 06 Plug with Ex d Gland Size A .3307"/8.4mm O.D. unarmored cable, Insert #327 with Normal Key. Crimp Socket Contacts 3 X 12 Awg

EP17-1-0006-327PN

Shell size 06 Panel Mount Receptacle for Potting, Insert #327 with Normal Key. Crimp Pin Contacts 3 X 12 Awg

* - Consult factory for availability



Connector Component Overview

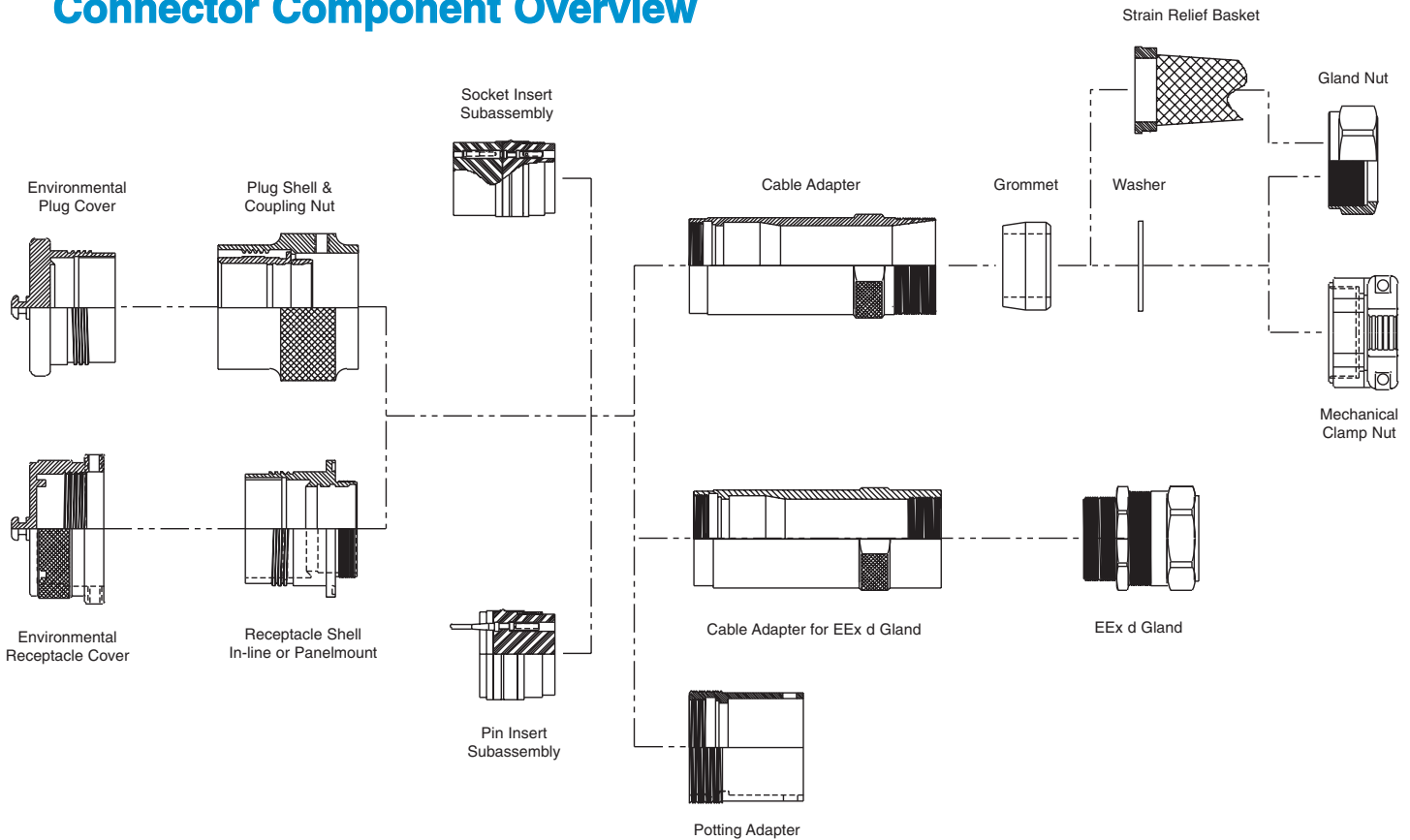

Assembled Connector Part Number examples:

EP15-2

Black Hardcoated In-Line Receptacle with Environmental Cover & Mechanical Clamp



EP15-4

Black Hardcoated In-Line Receptacle with Environmental Cover & Basket Weave Grip/Gland Nut



EP17-1

Black Hardcoated Panel Mount Receptacle for potting with Environmental Cover



EP13-3

Black Hardcoated Plug with Environmental Cover and ATEX Gland Nut



Explosion Proof Connector Major Components

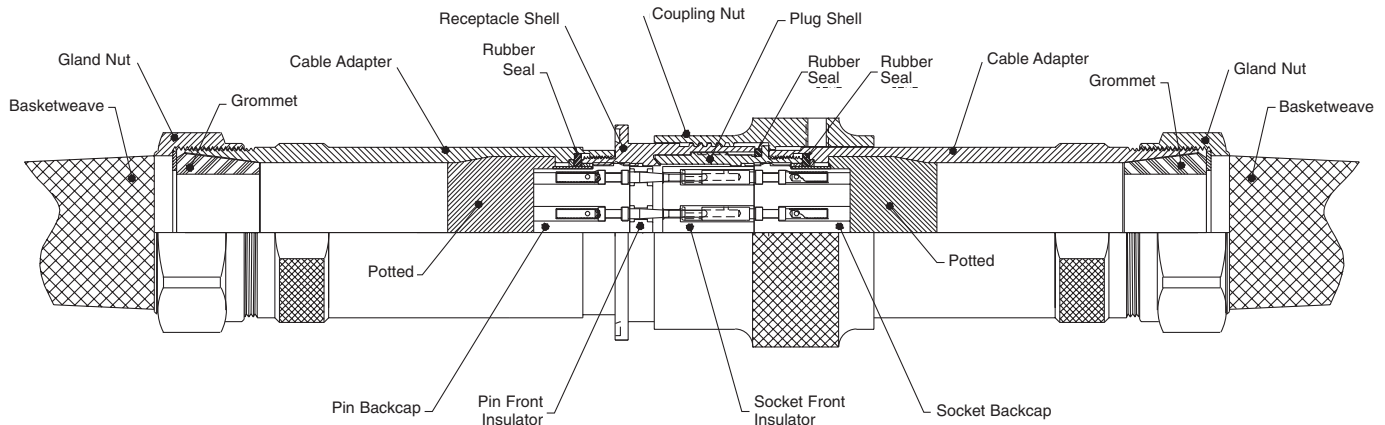

In-Line Receptacle Assembly

Plug Assembly

The Cadillac EP Series is derived from the Clements CN Series, a UL and CSA certified ruggedized general purpose connector that has earned a reputation for performance and quality in the Industrial and Marine, Oil and Gas Markets. As an outgrowth and variant of Mil-C-5015 threaded connectors the CN Series provides a flexible design for the toughest connector applications. In keeping with the same performance as the CN Series, Clements has introduced the EP Series, offering increased performance and explosion protection in hazardous environments. Clements has certified this connector series for use in a Zone 1, Gas IIC and Dust 21 environments with IP68 environmental sealing characteristics and T6 temperature class.

The connector hardware is manufactured from a machined aluminum alloy with a durable hard anodized black finish. Alternate materials are available upon request by consulting the factory. The black hard anodized finish is scratch resistant and is available in the following shell styles; panel mount receptacle, fixed in-line receptacle, in-line receptacle and plug. The EP Series adds specially designed plug and receptacle shells with protected coupling nut and environmental dust covers for hazardous locations. The same rugged backshell hardware as offered in the CN Series is available; basketweave, mechanical clamp, standard gland nut (potting required) and Ex d approved cable glands. The EP Series backshell hardware offers extended length cable adapters to provide cable protection and ease of assembly of multiple cable terminations. Offered with customizable rubber cable grommets and washers to fit various cable OD's these components provide the added environmental sealing and performance required in hazardous applications. The plug connector coupling is designed for quick mating and unmating with a robust self-cleaning threaded design. Locking is provided on the plug coupling nut with two allen head set screws. The EP Series connector hardware is specially designed for optimum interface length and tolerances to ensure explosion protection as certified in hazardous environments.

Clements offers a versatile, reverse gender, field installable insert system. All inserts can be supplied with alternate polarization to prevent unwanted mateability. This feature is especially useful in applications utilizing multiple connectors of the same configuration. As on our CN Series a comprehensive range of inserts is available to suit wire sizes #18 awg to 4/0 awg in single or multiple or mixed configurations. Clements EP Series insert configurations are listed on pages 9 – 13. Three insert styles are offered; crimp, solder or pressure termination. Contacts are manufactured using high performance copper alloy with standard silver plating and optional gold plating available. Please refer to insert chart on page 9 to determine available insert style. While each of these styles provide a slightly different insert design, all insert types provide water, vapor, moisture and dust resistance. All three styles offer a rugged rigid front dielectric for pin and socket configurations. No matter which EP Series insert you select, the three termination styles offer versatility and serviceability without sacrificing performance.



Plug Assemblies

EP13-2 Style Plug with Mechanical Clamp (must be potted)

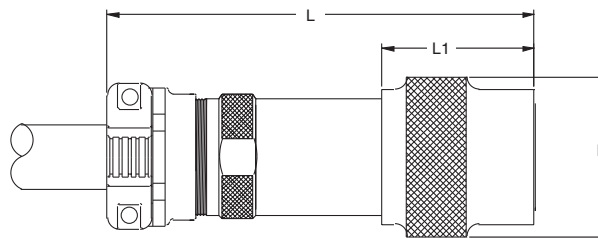

Shell Size	Dimensions		
	L	L1	D
06	6.80	3.07	2.20
08	8.80	3.07	2.70
10	8.80	3.07	3.20
C10	9.30	3.57	3.20
12	8.80	3.07	3.70
C12	9.30	3.57	3.70

EP13-3 Style Plug with Ex D Gland Nut

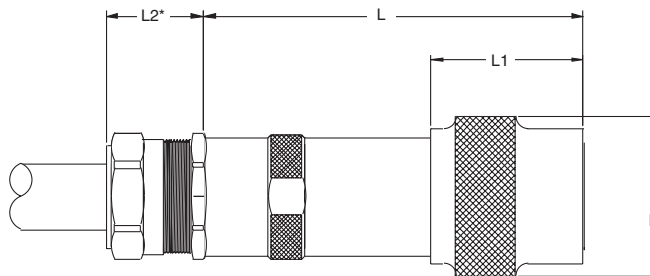

* - L2 dimensions are determined by ATEX gland selection

Shell Size	Dimensions		
	L	L1	D
06	5.60	3.07	2.20
08	7.60	3.07	2.70
10	7.60	3.07	3.20
C10	8.10	3.57	3.20
12	7.60	3.07	3.70
C12	8.10	3.57	3.70

EP13-4 Style Plug with Basketweave (must be potted)

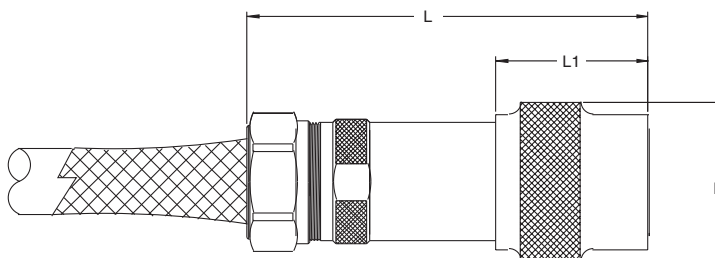

Shell Size	Dimensions		
	L	L1	D
06	6.25	3.07	2.20
08	8.25	3.07	2.70
10	8.25	3.07	3.20
C10	8.75	3.57	3.20
12	8.25	3.07	3.70
C12	8.75	3.57	3.70



In-Line Receptacle Assemblies

EP15-2 Style In-Line Receptacle with Mechanical Clamp (must be potted)

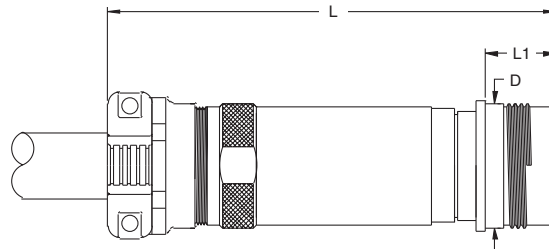

Shell Size	Dimensions		
	L	L1	D
06	7.00	1.40	1.50
08	9.00	1.40	2.00
10	9.00	1.40	2.50
C10	9.50	1.90	2.50
12	9.00	1.40	3.00
C12	9.50	1.90	3.00

EP15-3 Style In-Line Receptacle with Ex D Gland Nut

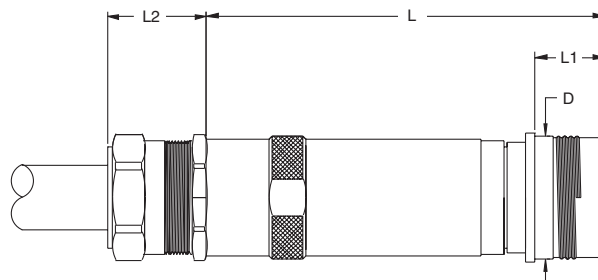

Shell Size	Dimensions		
	L	L1	D
06	6.00	1.40	1.50
08	8.00	1.40	2.00
10	8.00	1.40	2.50
C10	8.50	1.90	2.50
12	8.00	1.40	3.00
C12	8.50	1.90	3.00

EP15-4 Style In-Line Receptacle with Basketweave (must be potted)

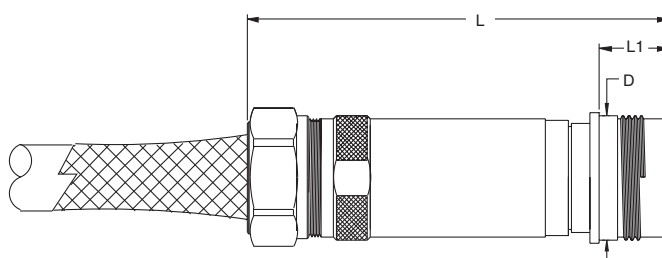

Shell Size	Dimensions		
	L	L1	D
06	6.50	1.40	1.50
08	8.50	1.40	2.00
10	8.50	1.40	2.50
C10	9.00	1.90	2.50
12	8.50	1.40	3.00
C12	9.00	1.90	3.00



Panel Mount & Fixed In-Line Receptacle Assemblies

EP17-1 Panel Mount Receptacle (must be potted)

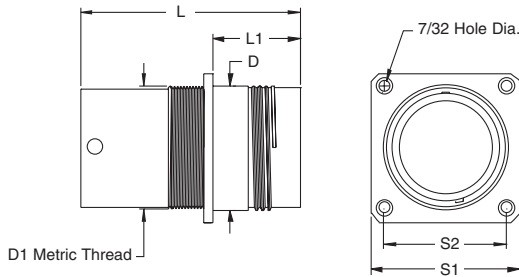

Shell Size	Dimensions					
	L	L1	D	D1	S1	S2
06	4.60	1.75	1.50	M40	2.30	1.65
08	4.60	1.75	2.00	M50	2.60	2.04
10	4.60	1.75	2.50	M63	3.00	2.44
C10	5.10	2.25	2.50	M63	3.00	2.44
12	4.60	1.75	3.00	M75	3.50	2.83
C12	5.10	2.25	3.00	M75	3.50	2.83

EP17-2 Fixed In-Line Receptacle with Mechanical Clamp (must be potted)

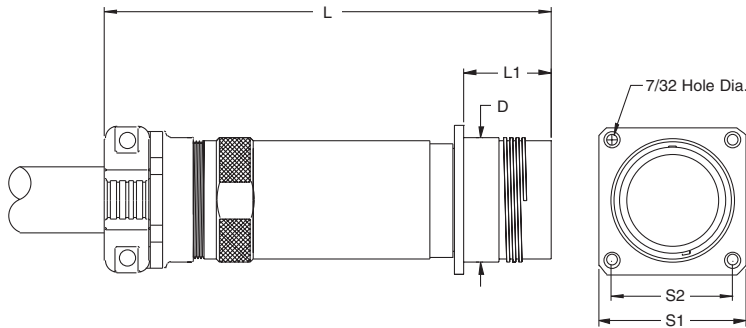

Shell Size	Dimensions					
	L	L1	D	S1	S2	
06	7.50	1.75	1.50	2.30	1.65	
08	9.50	1.75	2.00	2.60	2.04	
10	9.50	1.75	2.50	3.00	2.44	
C10	10.00	2.25	2.50	3.00	2.44	
12	9.50	1.75	3.00	3.50	2.83	
C12	10.00	2.25	3.00	3.50	2.83	

EP17-3 Fixed In-Line Receptacle with Ex d Gland Nut

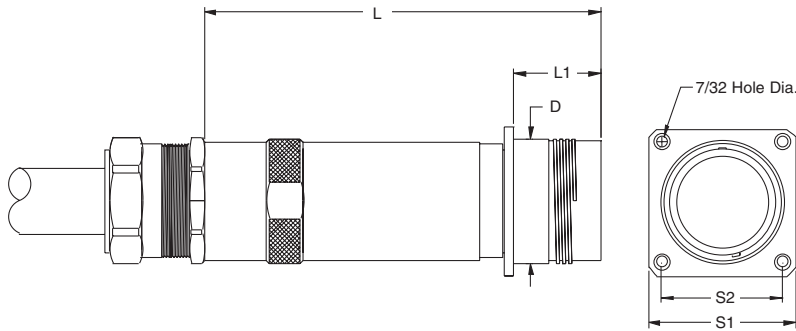

Shell Size	Dimensions					
	L	L1	D	S1	S2	
06	5.75	1.75	1.50	2.30	1.65	
08	7.75	1.75	2.00	2.60	2.04	
10	7.75	1.75	2.50	3.00	2.44	
C10	8.25	2.25	2.50	3.00	2.44	
12	7.75	1.75	3.00	3.50	2.83	
C12	8.25	2.25	3.00	3.50	2.83	

EP17-4 Fixed In-Line Receptacle with Basketweave (must be potted)

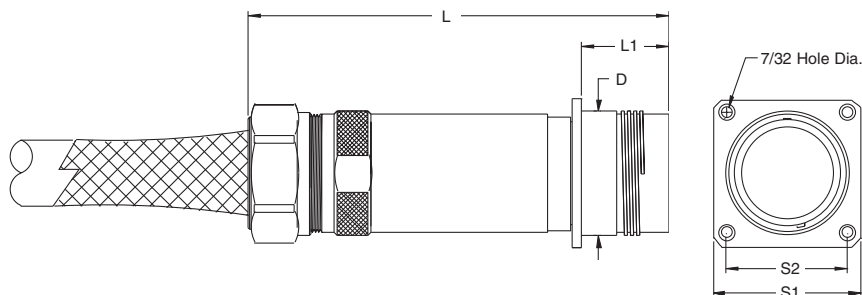

Shell Size	Dimensions					
	L	L1	D	S1	S2	
06	6.50	1.75	1.50	2.30	1.65	
08	8.50	1.75	2.00	2.60	2.04	
10	8.50	1.75	2.50	3.00	2.44	
C10	9.00	2.25	2.50	3.00	2.44	
12	8.50	1.75	3.00	3.50	2.83	
C12	9.00	2.25	3.00	3.50	2.83	



Insert Configurations

Introduction

Plug and receptacle contact inserts are selected according to requirements for Service Voltage Rating, Number of Contacts, Wire Size and Ampere Rating. Pin or socket inserts are interchangeable in male and female barrels. The EP Line Insert Configuration Listing is used to identify various contact insert arrangements. For the engineer, it provides visual selection of the insert configuration needed to satisfy his requirements. For the end user, the list provides general information useful in the termination of plugs and receptacles. To aid the reader, the insert configurations are presented in numerical order, based on the number of contacts in each.

The male insert illustration shown below (and those on the following pages) is shown as it appears when viewed from the front. Contacts are shown by both physical position within the configuration and by contact number. The contact number corresponds to the contact position shown on the rear face of the insert illustrated as well as to both the front and rear faces of the mating insert. The symbol used to show contact location is indicative of contact size. For example, the contact symbol in this illustration represents a #8 contact. An explanation of contact symbols is presented on each page of the listing. Each drawing also provides data on normal and alternate key positions. Drawings are reduced from actual size of the insert configuration.

Note: Alternate keying or insert polarization is intended to resist improper intermating of plugs and receptacles of like shell sizes and like insert arrangements.

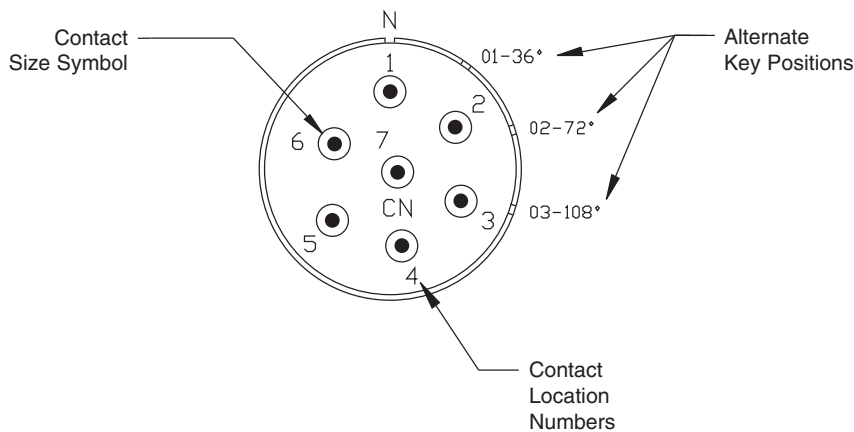

CONTACTS SYMBOLS								
AWG	18	16	12	10	8	4	1/0	4/0

GROUND	CONTACT	TERMINATION
CRIMP	SOLDER	PRESSURE

Service Voltage Rating: A = 240V, B,D & E = 600V



Insert Configurations

Insert Arrangement	Total Contacts	Crimp	Solder	Pressure	Service Rating	Contact Size								Page No.
						18	16	12	10	8	4	1/0	4/0	
CN-06-327	3	X			D			3						10
CN-06-349	3	X			D				3					10
CN-06-314	4	X			D				4					10
CN-06-316	4	X			D				4					10
CN-06-322	4	X			D				4					10
CN-06-22	4			X	D				4					-
CN-06-333	4	X			D		4							10
CN-08-328	4	X			D					4				10
CN-08-22	4		X	X	D						4			10
CN-08-38	4		X	X	D						4			10
CN-C10-40	4		X	X	D							4		11
CN-C10-42	4		X		D							4		11
CN-C12-26	4		X		D								4	12
CN-C12-38	4		X	X	D								4	12
CN-06-324	5	X			D			5						10
CN-06-353	5	X			D			5						10
CN-08-316	5	X			D				5					10
CN-08-375	5	X			D				5					10
CN-10-38	5		X		D						5			11
CN-10-84	5		X		D						5			11
CN-C12-49	5			X	E							5		12
CN-C12-72	6		X		D			3					3	12
CN-06-310	7	X			A			7						10
CN-06-354	7	X			A			7						10
CN-06-348	7	X			A		7							10
CN-10-359	7	X			D				7					11
CN-C12-353	8	X			A/B			4				4		12
CN-12-355	8	X			D						4	4		13
CN-06-355	10	X			A		10							10
CN-06-334	10	X			A		10							10
CN-08-376	10	X			D			6	4					10
CN-08-381	10	X			D			6	4					11
CN-10-380	10	X			D			6			4			11
CN-C12-375	10	X			D			6				4		13
CN-10-375	12	X			D				12					11
CN-08-325	16	X			D		16							11
CN-08-312	19	X			A			19						11
CN-08-377	19	X			A			19						11
CN-08-355	19	X			A		19							11
CN-10-376	19	X			D			19						11
CN-10-388	19	X			D			19						11
CN-10-332	20	X			A			20						12
CN-10-387	20	X			A			20						12
CN-08-335	27	X			A		24	3						11
CN-10-374	27	X			D/A			25			2			12
CN-08-321	37	X			A		37							11
CN-10-350	37	X			A			37						12
CN-10-386	37	X			A			37						12
CN-12-371	37	X			D		37							13
CN-12-352	58	X			A			58						13
CN-12-384	58	X			A			58						13
CN-10-313	68	X			A		68							12



Insert Configurations (Front view of male insert shown)

See page 9 for complete insert specifications.

Additional insert configurations are available upon request, consult the factory for more information.

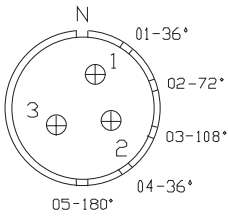

CN-06-327
3 #12 Contacts

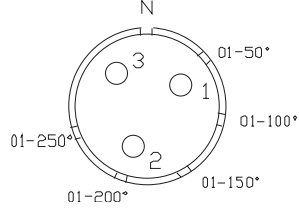

CN-06-349
3 #10 Contacts

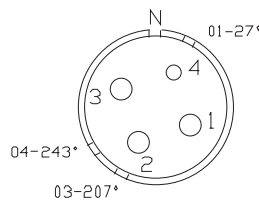

CN-06-314
4 #10 Contacts

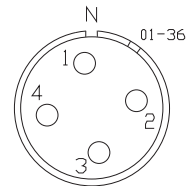

CN-06-316
4 #10 Contacts

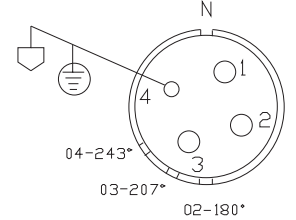

CN-06-322
4 #10 Contacts

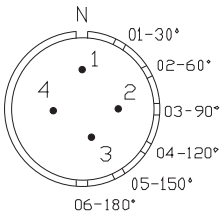

CN-06-333
4 #16 Contacts

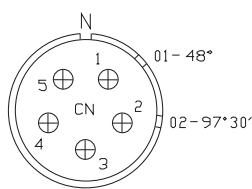

CN-06-324
5 #12 Contacts

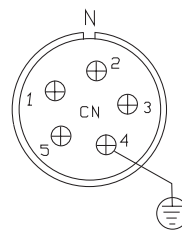

CN-06-353
5 #12 Contacts

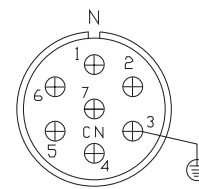

CN-06-310
7 #12 Contacts

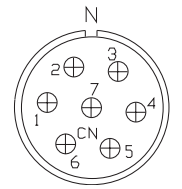

CN-06-354
7 #12 Contacts

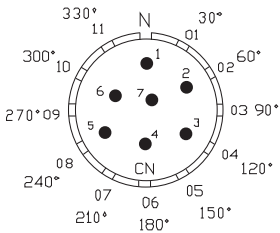

CN-06-348
7 #16 Contacts

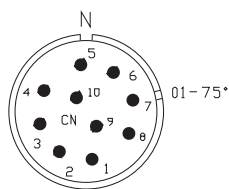

CN-06-355
10 #16 Contacts

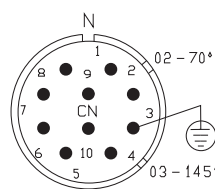

CN-06-334
10 #16 Contacts

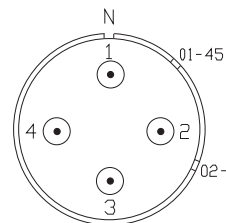

CN-08-328
4 #8 Contacts

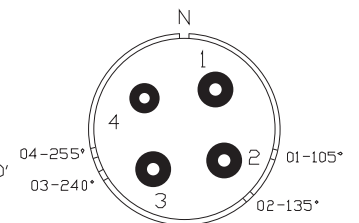

CN-08-22
4 #4 Contacts

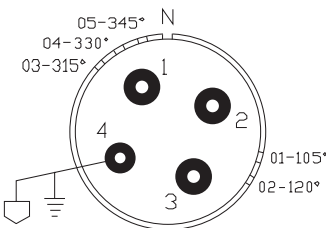

CN-08-38
4 #4 Contacts

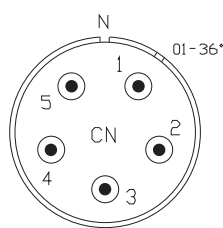

CN-08-316
5 #8 Contacts

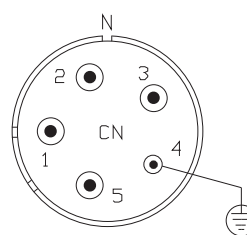

CN-08-375
5 #8 Contacts

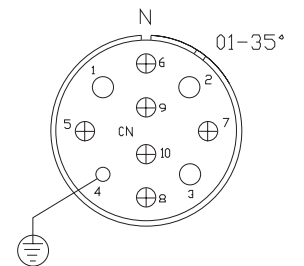

CN-08-376
6 #12 & 4 #10 Contacts

CONTACTS SYMBOLS								
AWG	18	16	12	10	8	4	1/0	4/0

GROUND	CONTACT	TERMINATION
CRIMP	SOLDER	PRESSURE

Service Voltage Rating: A = 240V, B,D & E = 600V



Insert Configurations (Front view of male insert shown)

See page 9 for complete insert specifications.

Additional insert configurations are available upon request, consult the factory for more information.

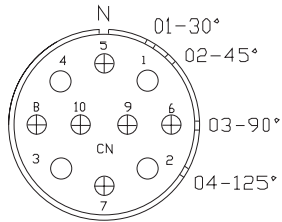

CN-08-381
6 #12 & 4 #10 Contacts

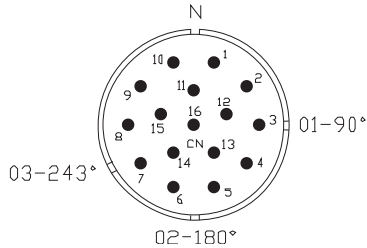

CN-08-325
16 #16 Contacts

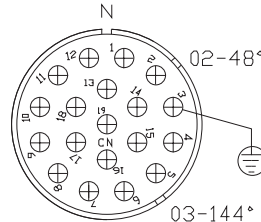

CN-08-312
19 #12 Contacts

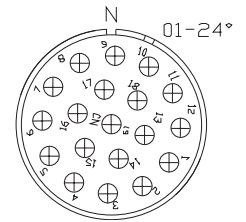

CN-08-377
19 #12 Contacts

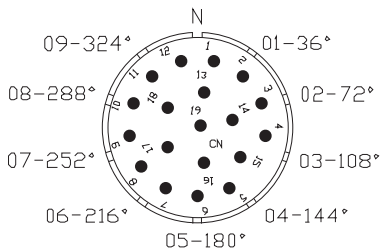

CN-08-355
19 #16 Contacts

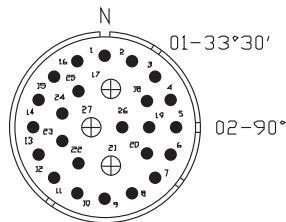

CN-08-335
24 #16 & 3 #12 Contacts

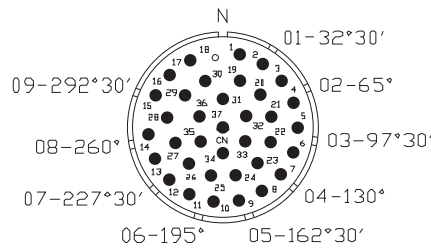

CN-08-321
37 #16 Contacts

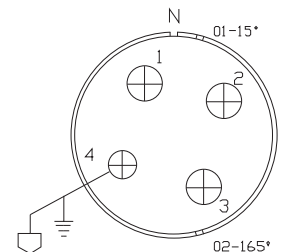

CN-C10-40
4 #1/0 Contacts

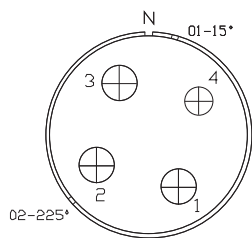

CN-C10-42
4 #1/0 Contacts

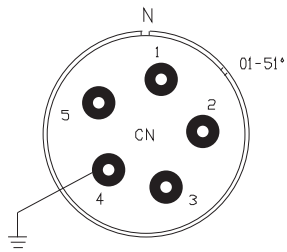

CN-10-38
5 #4 Contacts

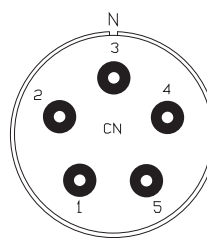

CN-10-84
5 #4 Contacts

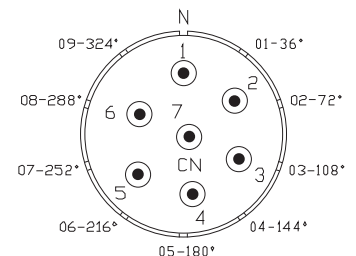

CN-10-359
7 #8 Contacts

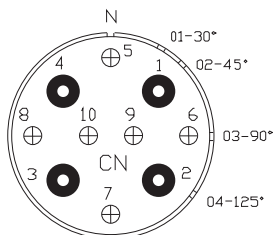

CN-10-380
6 #12 & 4 #4 Contacts

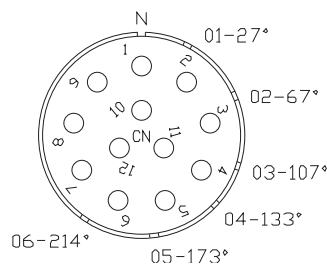

CN-10-375
12 #10 Contacts

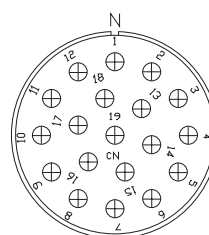

CN-10-376
19 #12 Contacts

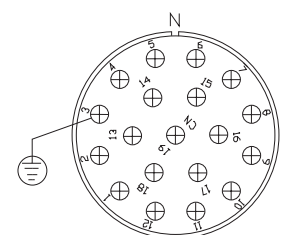

CN-10-388
19 #12 Contacts

CONTACTS SYMBOLS	○	●	⊕	○	⦿	⦿	⊕	⊕
AWG	18	16	12	10	8	4	1/0	4/0

GROUND	CONTACT	TERMINATION
CRIMP	SOLDER	PRESSURE

Service Voltage Rating: A = 240V, B,D & E = 600V



Insert Configurations (Front view of male insert shown)

See page 9 for complete insert specifications.

Additional insert configurations are available upon request, consult the factory for more information.

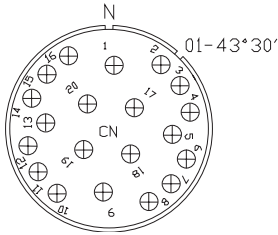

CN-10-332
20 #12 Contacts

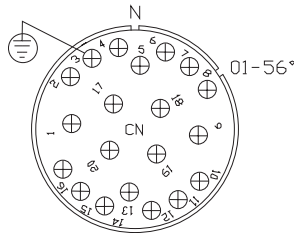

CN-10-387
20 #12 Contacts

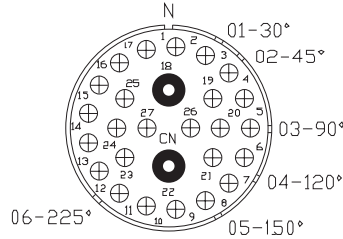

CN-10-374
25 #12 & 2 #4 Contacts

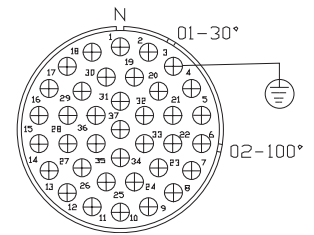

CN-10-350
37 #12 Contacts

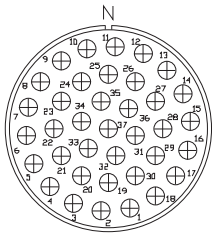

CN-10-386
37 #12 Contacts

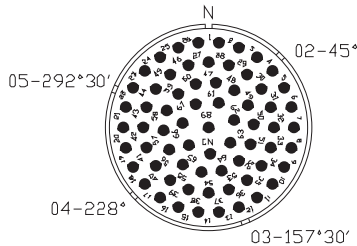

CN-10-313
68 #16 Contacts

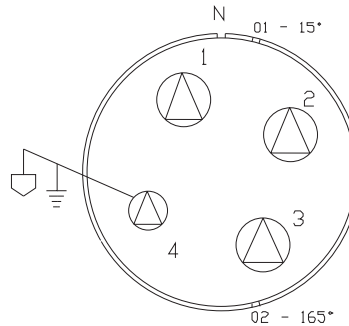

CN-C12-26
4 #4/0 Contacts

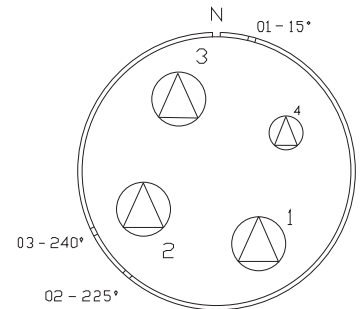

CN-C12-38
4 #4/0 Contacts

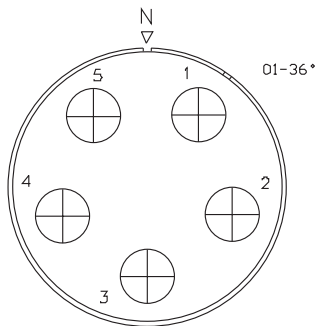

CN-C12-49
5 #1/0 Contacts

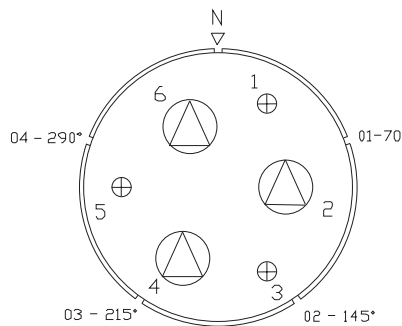

CN-C12-72
3 #12 & 3 #4/0 Contacts

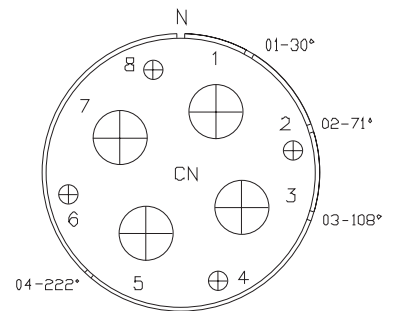

CN-C12-353
4 #12 & 4 #1/0 Contacts

CONTACTS SYMBOLS								
AWG	18	16	12	10	8	4	1/0	4/0

GROUND	CONTACT	TERMINATION
CRIMP	SOLDER	PRESSURE

Service Voltage Rating: A = 240V, B,D & E = 600V



Insert Configurations (Front view of male insert shown)

See page 9 for complete insert specifications.

Additional insert configurations are available upon request, consult the factory for more information.

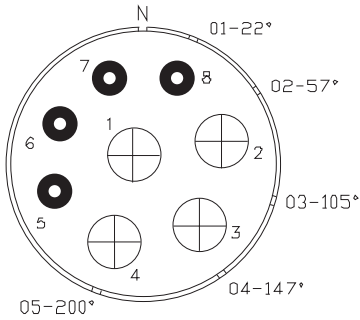

CN-12-355
4 #4 & 4 #1/0 Contacts

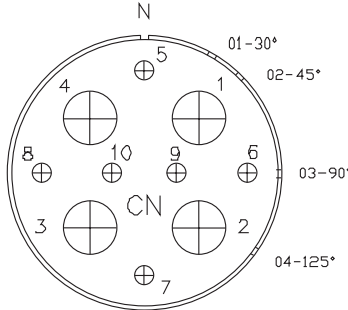

CN-C12-375
6 #12 & 4 #1/0 Contacts

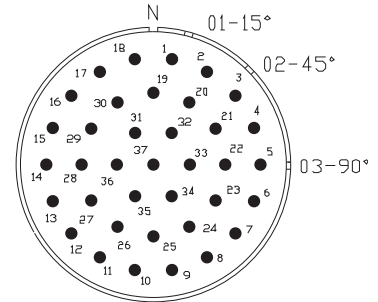

CN-12-371
37 #16 Contacts

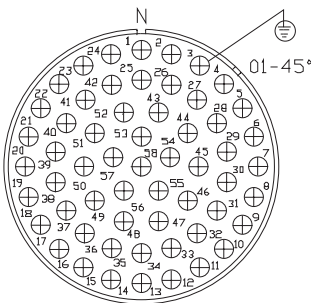

CN-12-352
58 #12 Contacts

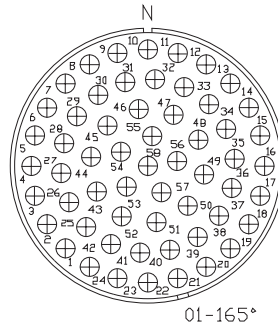

CN-12-384
58 #12 Contacts

CONTACTS SYMBOLS								
AWG	18	16	12	10	8	4	1/0	4/0

GROUND	CONTACT	TERMINATION
CRIMP	SOLDER	PRESSURE

Service Voltage Rating: A = 240V, B,D & E = 600V



Cable Grip Components

Shell Size	Cable Dia. Dimension		Cable Dia. Code No.*	Oil Resistant Rubber Grommets Part No.	Steel Gland Washers Part No.	Stainless Steel Basket Weave Grips	
	Min.	Max				Part No.	Nominal Length Inches
06	.062	.125	02	CN-6306-02C	CN-8006-4E	CN-5006-4E	3
	.125	.250	04	CN-6306-04C	CN-8006-4E	CN-5006-4E	3
	.250	.375	06	CN-6306-06C	CN-8006-8E	CN-5006-6E	4
	.375	.500	08	CN-6306-08C	CN-8006-8E	CN-5006-8E	5
	.500	.625	10	CN-6306-10C	CN-8006-12E	CN-5006-10E	6
	.625	.750	12	CN-6306-12C	CN-8006-12E	CN-5006-12E	7
	.750	.875	14	CN-6306-14C	CN-8006-15E	CN-5006-14E	7 ½
	.875	.937	15	CN-6306-15C	CN-8006-15E	CN-5006-15E	8
08	.250	.375	06	CN-6308-06C	CN-8008-8E	CN-5008-6E	4
	.375	.500	08	CN-6308-08C	CN-8008-8E	CN-5008-8E	5
	.500	.625	10	CN-6308-10C	CN-8008-12E	CN-5008-10E	6
	.625	.750	12	CN-6308-12C	CN-8008-12E	CN-5008-12E	7
	.750	.875	14	CN-6308-14C	CN-8008-16E	CN-5008-14E	7 ½
	.875	1.000	16	CN-6308-16C	CN-8008-16E	CN-5008-16E	8 ½
	1.000	1.125	18	CN-6308-18C	CN-8008-20E	CN-5008-18E	9
	1.125	1.250	20	CN-6308-20C	CN-8008-20E	CN-5008-20E	10
	1.250	1.375	22	CN-6308-22C	CN-8008-23E	CN-5008-22E	10 ½
1.375	1.437	23	CN-6308-23C	CN-8008-23E	CN-5008-23E	10 ½	
10 & C10	.500	.625	10	CN-6310-10C	CN-8010-12E	CN-5010-10E	6
	.625	.750	12	CN-6310-12C	CN-8010-12E	CN-5010-14E	7 ½
	.750	.875	14	CN-6310-14C	CN-8010-16E	CN-5010-14E	7 ½
	.875	1.000	16	CN-6310-16C	CN-8010-16E	CN-5010-18E	9
	1.000	1.125	18	CN-6310-18C	CN-8010-20E	CN-5010-18E	9
	1.125	1.250	20	CN-6310-20C	CN-8010-20E	CN-5010-20E	10
	1.250	1.375	22	CN-6310-22C	CN-8010-24E	CN-5010-24E	11
	1.375	1.500	24	CN-6310-24C	CN-8010-24E	CN-5010-24E	11
	1.500	1.625	26	CN-6310-26C	CN-8010-28E	CN-5010-28E	13
	1.625	1.750	28	CN-6310-28C	CN-8010-28E	CN-5010-28E	13
	1.750	1.875	30	CN-6310-30C	CN-8010-31E	CN-5010-31E	14 ½
1.875	1.937	31	CN-6310-31C	CN-8010-31E	CN-5010-31E	14 ½	
12 & C12	.875	1.000	16	CN-6312-16C	CN-8012-16E	CN-5012-16E	8 ½
	1.000	1.125	18	CN-6312-18C	CN-8012-20E	CN-5012-20E	10
	1.125	1.250	20	CN-6312-20C	CN-8012-20E	CN-5012-20E	10
	1.250	1.375	22	CN-6312-22C	CN-8012-24E	CN-5012-24E	11
	1.375	1.500	24	CN-6312-24C	CN-8012-24E	CN-5012-24E	11
	1.500	1.625	26	CN-6312-26C	CN-8012-28E	CN-5012-28E	13
	1.625	1.750	28	CN-6312-28C	CN-8012-28E	CN-5012-28E	13
	1.750	1.875	30	CN-6312-30C	CN-8012-32E	CN-5012-32E	15
	1.875	2.000	32	CN-6312-32C	CN-8012-32E	CN-5012-32E	15
	2.000	2.125	34	CN-6312-34C	CN-8012-36E	CN-5012-36E	16
	2.125	2.250	36	CN-6312-36C	CN-8012-36E	CN-5012-36E	16
2.250	2.375	38	CN-6312-38C	CN-8012-39E	CN-5012-39E	17 ½	
2.375	2.437	39	CN-6312-39C	CN-8012-39E	CN-5012-39E	17 ½	

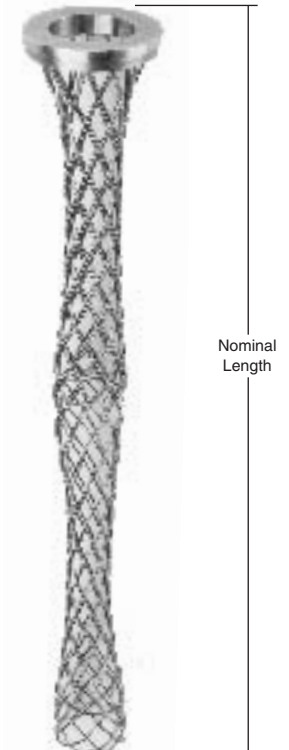
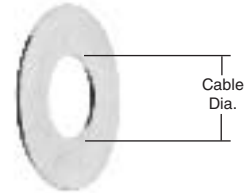



Ex d Gland Size and Cable Types

Clements National offers a variety of explosion proof cable glands to support our EP Series Connectors. Various gland selections are available for Unarmored Cable, Armored and Sheathed Cable and Armored and Sheathed with Reduced Bore. All glands are certified for use in hazardous locations and feature elastomeric or compound barrier seals.

Ex d Cable Gland	Unarmored Cable No deviation if		Armored & Sheathed Cable - BS				Armored & Sheathed with reduced bore - BSR	
	Unarmored		UA		Standard		OD - Reduced	
Size Code	Min.	Max.	Min.	Max.	Min.	Max.	Min.	Max.
A1 (16)	.1338 (3.4)	.3307 (8.4)	.1339 (3.4)	.3307 (8.4)	.3543 (9.0)	.5315 (13.5)	.2638 (6.7)	.4055 (10.3)
A2 (20s)	.2835 (7.2)	.4606 (11.7)	.2835 (7.2)	.4606 (11.7)	.4528 (11.5)	.6299 (16.0)	.3701 (9.4)	.4921 (12.5)
A (20)	.3700 (9.4)	.5512 (14.0)	.3700 (9.4)	.5512 (14.0)	.6102 (15.5)	.8307 (21.1)	.4724 (12.0)	.6929 (17.6)
B (25)	.5315 (13.5)	.7874 (20.0)	.5315 (13.5)	.7874 (20.0)	.7992 (20.3)	1.079 (27.4)	.6614 (16.8)	.9409 (23.9)
C (32)	.7677 (19.5)	1.035 (26.3)	.7677 (19.5)	1.035 (26.3)	1.051 (26.7)	1.339 (34.0)	.9134 (23.2)	1.201 (30.5)
C2 (40)	.9055 (23.0)	1.268 (32.2)	.9055 (23.0)	1.268 (32.2)	1.299 (33.0)	1.598 (40.6)	1.126 (28.6)	1.425 (36.2)
D (50s)	1.106 (28.1)	1.504 (38.2)	1.106 (28.1)	1.504 (38.2)	1.551 (39.4)	1.839 (46.7)	1.370 (34.8)	1.669 (42.4)
D2 (50)	1.303 (33.1)	1.736 (44.1)	1.303 (33.1)	1.736 (44.1)	1.799 (45.7)	2.094 (53.2)	1.618 (41.1)	1.909 (48.5)
E (63s)	1.543 (39.2)	1.972 (50.1)	1.543 (39.2)	1.969 (50.0)	2.051 (52.1)	2.343 (59.5)	1.870 (47.5)	2.157 (54.8)
E2 (63)	1.839 (46.7)	2.205 (56.0)	1.839 (46.7)	2.205 (56.0)	2.299 (58.4)	2.591 (65.8)	2.118 (53.8)	2.409 (61.2)

Consult factory for other sizes and styles



Clements EX d Cable Glands are offered in different styles and functions to suit your specific cable application. It's always good practice to follow some basic gland selection guidelines:

- Determine cable overall diameter
- Determine type of cable; unarmored, armored or armored and sheathed
- Determine type of armor and thickness where applicable
- Determine inner cable bundle diameter if applicable
- Determine cable gland size
- Determine any access limitations or space restrictions
- Determine environmental conditions and level of protection



Contact Crimping and Insertion/Removal Tools

Full Cycle Crimp Tool

TC-CN-M309

This tool is a full cycle crimp tool for crimping Clements crimp contact sizes #10 AWG through #16 AWG.

(to be used with following locator dies TC-CN-XX-20L)



Locator Dies for TC-CN-M309 Crimp Tool

TC-CN-10-20L

Locator die for #10 AWG pin/socket crimp contacts

TC-CN-12-20L

Locator die for #12 AWG pin/socket crimp contacts

TC-CN-16-20L

Locator die for #16 AWG pin/socket crimp contacts



Insertion Tool for Pin/Socket Crimp Contacts

TI-10

Insertion tool for #10 AWG pin/socket crimp contact.

TI-12

Insertion tool for #12 AWG pin/socket crimp contact.

TI-16

Insertion tool for #16 AWG pin/socket crimp contact.



Removal Tool for Pin Crimp Contacts

TEP-LG

Removal tool for #8, #10 and #12 AWG pin crimp contact.

TEP-SM

Removal tool for #16 AWG pin crimp contact.



Removal Tool for Crimp Socket Contacts

TES-10

Removal tool for #10 socket crimp contact.

TES-12

Removal tool for #12 socket crimp contact.

TES-16

Removal tool for #16 socket crimp contact.



Note: To order complete insertion/removal tool kits per contact size use the following part numbers: **TCN-10** (#10 AWG), **TCN-12** (#12 AWG), **TCN-16** (#16 AWG).

Consult the factory for availability of crimping tools for other wire size contacts.



General Assembly Instructions and Precautions

1. Read assembly instructions before actually starting to assemble connectors to identify the various component parts, and to check for any missing parts.
2. Cut cable jacket and sheathing squarely and to correct length, using wire strippers that have been approved for the operation. In preparing the individual wires in cables and harnesses for assembly, make allowances in length for reaching the outer most circle of contact cavities in the conductors. The insulation should be cut progressively longer as they extend out from the center of the cable or harness to assure sufficient length.
3. Follow the Contact Rating/Dimensions Table covering maximum cable stripping lengths for effective cable gland sealing. All conductors should be fit into contact wire wells correctly. A practice layout should be done so that an assembler can oversee what the finished termination will look like.
 - a. Crimping and terminating of conductors to contacts must be done carefully. Make certain that all wire strands are fully bottomed in contact wells by checking through inspection hole provided.
 - b. When contacts are to be soldered, avoid direct contact of soldering tools to inserts. An open flame or hot soldering tip can carbonize insulating materials and make them useless.
 - c. Soldering conductors to contacts must be done carefully and a non-conductive flux should be used to avoid corrosion or hygroscopic action. Do not use solder salts or acids, because they may affect the dielectric properties of insulation materials.
4. Before starting actual termination of wires, it is essential that cables and harnesses be laid out in a specific order in accordance with the wiring diagram. Proper layout will eliminate the need for twisting and crossover of conductors. If the wiring layout is not correct, the termination operation will be difficult or even impossible and the chances for making errors will be increased. Cable and harness assemblies having a spiral layout must also be matched carefully to the correct contacts in both the male and female inserts.
5. Some cables that will be used will have a “basket weave” type of armor under the outer jacket (sheath) and over the inner jacket. Since many regulatory entities require that the armor be grounded at least at the source end, it is beneficial to ground the armor via a spare contact within the connector. Follow the removal of sufficient amount of armor can be clipped away, but not all. An adequate amount should remain in order that a small cross-section conductor, short in length, be woven into the remaining armor weave and either soldered or covered with mastic impregnated heat shrink, creating an intimate bond to the armor. At the opposite end of the short piece of wire a contact should be crimped and inserted into the insert.
6. Use only correctly sized and provided Exd glands to assure resistance to moisture and other contaminates. Use only correct size sealing grommets to assure resistance to moisture and other contaminants. Make certain that the cable jacket is smooth where a grommet is to seal. Remove any grooves or ridges if present by sanding or scarfing.
7. Use only the proper crimping tools that have been set or calibrated with precision gages. See Crimping and Insertion/Removal Tools page.
8. Make certain that all contacts are the correct size before attempting to assemble in insert cavities. This point is particularly important when both power and control types of contacts are used in the same connector.
9. Be sure that ground contacts are correctly located.
10. Seat all contacts properly so that they will not be damaged or become disengaged during connector mating operation.
11. Use only the proper insertion tools and be sure that they are aligned axially when pushing contact into their fully seated position. See Crimping and Insertion/Removal Tools page.
12. When inserts have more cavities than the conductors, plug unused cavities with furnished contacts.
13. After all terminated contacts are inserted in their respective cavities and inspected, the cable adapter or insert clamp nut should be tightened with a wrench. This assembly operation should be done by placing the components in a vise with smooth-faced jaws and using a strap wrench.
14. When handling cables, use adequate support to prevent damage to the internal wires. Exd glands are intended for sealing purposes and should not be used as a cable grip.
15. If for any reason terminated conductors have to be removed from an insert because of any assembly error or change in circuitry, be sure to remove the cable clamp or insert clamp nut first before extracting the contact and reinserting it. This step is important because any attempt to remove the contacts when the resilient insulator components are compressed will result in damage.
16. If one of the connector poles is a ground wire, make sure that it is grounded properly before the connector actually is engaged.
17. When connectors using the same configuration are mounted close together, different or alternate key arrangements should be used to prevent mismatching and possible damage to the electrical system.



18. Always inspect all aspects of a connector before actual operation. It is recommended that normal DWV and IR tests be performed on assemblies before using.

19. Never try to straighten bent contacts. Straightening cannot be done properly and the plating on contacts very likely will be marred. This will result in a high resistance connection and will expose the base material to possible corrosion.

20. A careful review should be made of the mixing instructions that follow. Potting of the connector where required should be the very last step the assembler does prior to fastening down the grommet and nut on the cable adapter. 'Ringing' out of the contacts with their mate should be done prior to potting. Review the mixing instructions for potting compound carefully.

21. When potting connectors, be sure to apply potting only in mated condition to assure that contacts will align properly.

22. Each assembly operator should be his own inspector. Worn, damaged, or defective tools should be reported immediately to foreman and supervisors. Assembly operators should be indoctrinated with this attitude and made to understand the importance of always guarding quality. Assembly workmanship is a significant factor in assuring the quality of multiple contact connectors. Quality cannot be "inspected" into connectors; it must be "built-in" during each and every assembly operation

23. Do not attempt to remove inserts that are bonded or locked in place in their shells.

24. Be certain that all components or connectors are assembled. Each part performs a vital function and it would not be included if it wasn't useful.

25. The equipment may be used with flammable gases and vapors with apparatus group(s) IIA, IIB, & IIC and with temperature classes T6.

26. The equipment is only certified for use in ambient temperatures in the range -20°C to +40°C and should not be used outside this range.

INSTALLATION, INSPECTION, MAINTENANCE and REPAIR

Installation shall be carried out by suitably-trained personnel in accordance with the European standards and local code of practice.

It is the end user's responsibility to ensure that the product, as specified and confirmed by the product label, is suitable for its intended application.

Inspection and maintenance of this equipment shall be carried out by suitably trained personnel in accordance with the European standards and local code of practice.

Repair of this equipment shall be carried out by suitably trained personnel in accordance with the European standards and local code of practice.

The certification of this equipment relies upon the following materials used in its construction:

Connector Material: ASTM B211 or B221 6061-T6 Aluminum
 O-ring Seal Material: Buna Rubber and Neoprene with Durometer of 60 SHORE A
 Potting Compound: 3M Scotchcast Resin4.

If the equipment is likely to come into contact with aggressive substances, then it is the responsibility of the user to take suitable precautions that prevent it from being adversely affected, thus ensuring that the type of protection provided by the equipment is not compromised.

Aggressive substances: e.g. acidic liquids or gases that may attack metals, or solvents that may affect polymeric materials.

Suitable precautions: e.g. regular checks as part of routine inspections should be established looking for corrosion and exposure to aggressive substances.

SPECIAL CONDITIONS FOR SAFE USE:

The "X" suffix to the certificate number relates to the following special condition(s) for safe use:

1. For plugs and receptacles that use certified cable glands, the gland must have a temperature range at their point of mounting between -20°C to 85°C.

2. Cables fitted to the plugs and receptacles shall be suitable for continuous operating temperature of at least 90°C.

3. Plugs are not permitted to remain energized when not engaged to the receptacles as per EN 60079-0; clause 20.2 (See #4)

4. An explosion proof environmental cap must be fitted to the receptacles or plugs to be re-energized when they are not mated. (See #3)

5. If the connector does not incorporate an external earth/ground facility. It is the responsibility of the user or installer to ensure adequate internal earth/ground continuity by means of terminating ground wire to spare contact within the insert patterns for both plug and receptacles to allow for continuity.

6. The panel mount receptacles shall only be used where the temperature at the point of entry in service on the associated enclosure is between -20°C to 90°C.



Contact Preparation Instructions

Crimp Tools:
See Tool Page for choice of turret head and selection setting according to contact size, part number and wire gage size.

Wire Preparation and Crimping:
Strip wire to required length. See Contact rating and dimensions table below . When using hot wire stripping do not wipe melted insulation material on wire strands; with mechanical strippers do not cut or nick strands.

Setting Up and Operation: Consult Tool Manufacturer

Contact Ratings/Dimensions

Wire Well Dimensions - All Min. in inches (mm)

Contact Size AWG/MM	N.E.C. Ampere Rating**	Solder		Crimp*		Crimp Pullout*** lbs. (N)	Pressure Contact Torque In./lbs. (N.M)
		Dia.	Depth	Dia.	Depth		
#16 (1.5)	16	.078 (2.00)	.203 (5.15)	.078 (2.00)	.500 (12.70)	50 (222.4)	-
#12 (4.0)	30	.110 (2.80)	.250 (6.45)	.110 (2.80)	.500 (12.70)	110 (489.3)	-
#10 (6.0)	40	.142 (3.60)	.394 (10.00)	.142 (3.60)	.591 (15.00)	180 (800.7)	15 (1.7)
#8 (10.0)	50	.209 (5.30)	.516 (9.12)	.189 (4.80)	.748 (19.00)	225 (1000)	25 (2.8)
#4 (25.0)	90	.329 (8.35)	.580 (14.70)	.285 (7.24)	.875 (22.20)	400 (1779)	20 (2.3)
#1/0 (50.0)	155	.470 (11.50)	.641 (16.30)	.450 (11.40)	.775 (19.70)	550 (2447)	50 (5.7)
#4/0 (120.0)	225	.650 (16.50)	.885 (22.50)	.620 (15.70)	1.00 (25.40)	875 (3892)	100 (11.3)

* - Includes wire inspection holes.

** - Maximum conductor ampacities must be calculated according to the specific insert selected and NEC Paragraph 310.15 and Table 310.16 so not to exceed the T6, 85°C connector shell rating.

*** - Maximum ampacity shall be calculated using 75°C ampacity values, compensated by the bundling factor as well as adjustment to 40°C ambient. Conductor insulation used in these applications shall be greater than 85°C.

Design Considerations - Note that the establishment of electrical factors such as overload protection is left entirely in the designer’s hands since he is in the best position to know what voltage, switching surges, transients, etc, can be expected in a particular circuit.

Connector Assembly Instructions

Assembling In-Line Plug and In-Line Receptacle Connectors

1. Slide the specified components onto the cable about 12”, threaded end last.
 - a. When specified, slide the cable mechanical strain relief nut, grommet washer and grommet onto the cable.
 - b. When specified, slide the required Atex gland (threaded end last) onto the cable.
2. Slide the Cable Adapter onto the cable, up to the EX Gland, large diameter first.
3. Slide the Coupling nut onto the cable, up to the Cable Adapter, Grub Screw end first when required.
4. Group all conductors according to size to facilitate orderly termination.
5. Working on one conductor at a time, strip the insulation off per the wire stripping length given in Figure 1 and terminate a contact to it, using a properly adjusted crimp tool, following crimp instruction found in Contact Preparation Instructions. Repeat the process for each conductor. Populate the insert with contacts by poking each of the wired contacts into its respective insert cavity following an electrical schematic or the system you are wiring.

6. For Plug Assemblies, make sure the Grub Screws are fully retracted then slide the Coupling Nut up onto the plug shell until seated against it’s mating shoulder.
7. Thread the Cable Adapter onto the plug shell, and hand tighten.
8. Thread the EX Gland onto the Cable adapter, and hand tighten.
9. Using a strap wrench, fully tighten the cable adapter onto the plug shell.
- 10a. For Ex Gland Assemblies:
Position the cable correctly. Using a hex wrench, tighten the Ex Gland. The seal must grip the outer jacket of the cable when the cable gland is tightened. Tighten Back Nut (or Conduit Receptor) to Entry Body. Ensure seal makes full contact with cable sheath. Tighten an extra 1-1/2 turns (up to 2-1/2 turns for minimum cable).
- 10b. For mechanical and Basket Weave Assemblies:
Follow potting instructions prior to installation of grommet and mechanical clamp or basket weave hardware.



Connector Mating Instructions:

CAUTION: Make sure power has been turned off from the connectors before mating and un-mating.

Mating:

1. Turn power off, then remove environmental covers from their respective connectors, make sure to retract the locking grub screws to prevent thread damage.
2. Mating, insert the plug into the receptacle by hand, then draw up the coupling nut by hand, using strap wrench fully tighten coupling nut to affect environmental seals. Tighten locking grub screws. Inspect work. Turn power on.

Unmating:

1. Turn power off, loosen locking grub screws, using strap wrench, loosen coupling nut fully. Remove plug from receptacle by hand.
2. Install respective environmental covers tighten with strap wrench and lock in place by using grub screws. Inspect work before turning power on.

Preparing a Bulkhead Receptacle Connector for Enclosure Mounting.

1. Slide the Bulkhead Adapter onto the cable, or conductor group; knurled end first.
2. Terminate each conductor with it's proper contact.
3. Populate the insert with contacts by poking each of the wired contacts into it's respective insert cavity, following an electrical schematic for the system you are wiring.
4. Slide the bulkhead adapter back down the conductors, and screw it onto the panel mount receptacle.
5. Use a strap wrench to tighten the bulkhead adapter until fully tightened to shoulder.
6. Referring to potting instructions, stand the assembly vertical, conductors pointing up, and fill the adapter with cement to a level 1/16" below the top of the adapter. After curing, this assembly is now permanently cemented, non-separable and non-repairable, and can be mounted to the bulkhead.
7. It is best to fit the connector to the bulkhead at a time when the free end of the cable is not terminated to the electrical system. If this is not possible, then it is necessary to rotate the connector assembly counter-clockwise to wind the cable/conductors so that when the assembly is threaded into a bulkhead in the subsequent instruction, the cable/conductors regain their most natural position, once the connector is mounted to the bulkhead. (Rotations required to be determined by end-user).

8. Thread the receptacle assembly into the bulkhead until the seal touches down, then tighten it by the smallest fraction of a revolution to the first instance that the mounting holes line up with the threaded enclosure holes.

9. Position the protective covers' lanyard tab over one of the mounting holes and screw a fastener through it. Apply the remaining fasteners to the other three holes with torque suitable for screw size used.

10. Install the protective cover and tighten fully.

11. Secure both grub screws to prevent unauthorized removal.

Potting Instructions

All cable adapters, other than ones suited for mating with an EX-certified gland, must be filled with encapsulate (potted). The material certified for use in filling this connector line is 3M Scotchcast Resin 4.

The user or installer shall consider the performance of these materials with regard to attack by aggressive substances that may be present in the hazardous area.

This material is a two-component casting system with a 1:1 volumetric mix ratio. Typical cure times at 70°F (21°C) are 1-2 hours and at 50°F (10°C) 4-8 hrs.

The product is available in pre-measured "mix & dispense" packaging. Potting material should be warmed to at least 60°F (16°C). Follow the instructions on the package for mixing and pouring.

More information is available by contacting the following authorized suppliers:

Eastern Connector Specialty Corp

566 Danbury Rd
 New Milford, CT 06776
 Toll Free: 1-877-788-0888
 Direct: 1-860-355-8100
 Fax: 1-860-350-5411
 E-mail: sales@easternconnector.com
 www.easternconnector.com



Bulkhead Adapter

Bulkhead adapters should be filled to a maximum of 1/16” below the top of the adapter. Care must be exercised so that the potting compound does not contaminate the bulkhead threads, or spill onto the outer surfaces of the receptacle flange.

In preparation for potting, the receptacle is to be mated to it’s corresponding plug, so that all contacts are mated and in their optimal post-potted position. When potting, the receptacle flange should be rigidly fixtured in a horizontal position. This fixture must be capable of holding the mated connector pair in that position for a minimum of 2 hours at room temperature. The exiting conductor/cable should be fixtured inline above the connector pair, during the entire curing process.

Mixing/Potting Instructions

1. CAUTION: Wear goggles or other eye protection during all operations. Do not use potting material that is 2 years beyond the manufacturing date marked on the package.

2. The potting compound is premeasured in “burst bag” packaging. This packaging consists of a single plastic bag that is compartmentalized into two chambers, each containing one part of the two part compound. The segregating feature is called a burst seal.

3. Lay the bag on a flat surface. Choosing either end of the bag that is parallel to the burst seal, start coiling/rolling the bag so that the compound in that half of the bag is pushed up against the burst seal.

4. Squeeze and apply pressure to the rolled side of the bag so that the compound bursts through the burst seal and joins the compound on the other side of the bag. Unroll the bag.

5. Mix the entire contents of the bag, by alternately squeezing the bag, and working the bag across the edge of a table, to fully move the entire contents of the bag, back and forth, between chambers. Work the material in this manner, constantly, for a minimum of 4 minutes.

6. Once mixed, squeeze all the contents away from one corner of the bag. fully clearing that corner of the bag of all compound.

7. Make a 3/16” pouring spout by snipping off the bags cleared corner.

8. To minimize air entrapment, slowly pour the compound into the back end of the bulkhead adapter.

9. Set the bag containing the remaining compound aside, so that it may cure. After cure, the bag may be disposed of safely, along with common consumer refuse.

CAUTION: As the remaining compound cures, the bag will become hot.

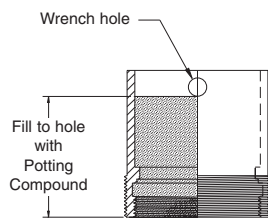

Panel Mount or Bulkhead Cable Adapter

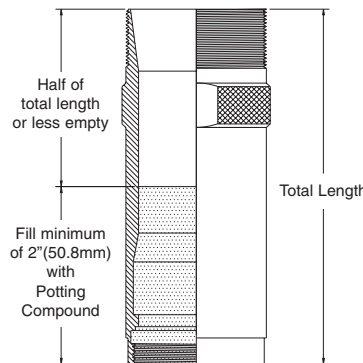

In-Line Cable Adapter

Labeling and Marking

Information below must be attached to connectors with a non-removable label:

DO NOT SEPARATE WHEN ENERGIZED
 Clements National, Chicago, IL 60638, USA
 Explosion Proof Line
 IIGD Ex d IIC T6 IP68 or IP68 IIGD Ex td A21 (for In-Line Plugs and Receptacles)
 IIGD Ex de IIC T6 IP68 or IP68 IIGD Ex td A21 (for Panel Mount Receptacles filled with cement)
 (Tamb = -20° C to + 40° C)
 Part Number, Serial Number
 Intertek ITES08ATEX15968X

This product complies with the following standards:

EN 60079-0:2006 General requirements for electrical apparatus for explosive gas atmospheres.

EN 60079-1:2007 Electrical apparatus for explosive gas atmospheres - Part 1: Flameproof enclosures “d” (Plus Cor 1) (IEC 60079-1:2003)

EN 60079-7:2003 Electrical apparatus for explosive gas atmospheres - Part 7: Increased safety “e” (IEC 60079-7:2001)

EN 61241-0:2006 General requirements for electrical apparatus for use in the presence of combustible dust

EN 61241-1:2004 Electrical apparatus for use in the presence of combustible dust. Protection by enclosures “tD”